

CDTop Technology



SA1209S/D Module EV-Kit User Manual



1. Hardware overview :

The EV-Kit's detail device description is shown below on Picture 1.

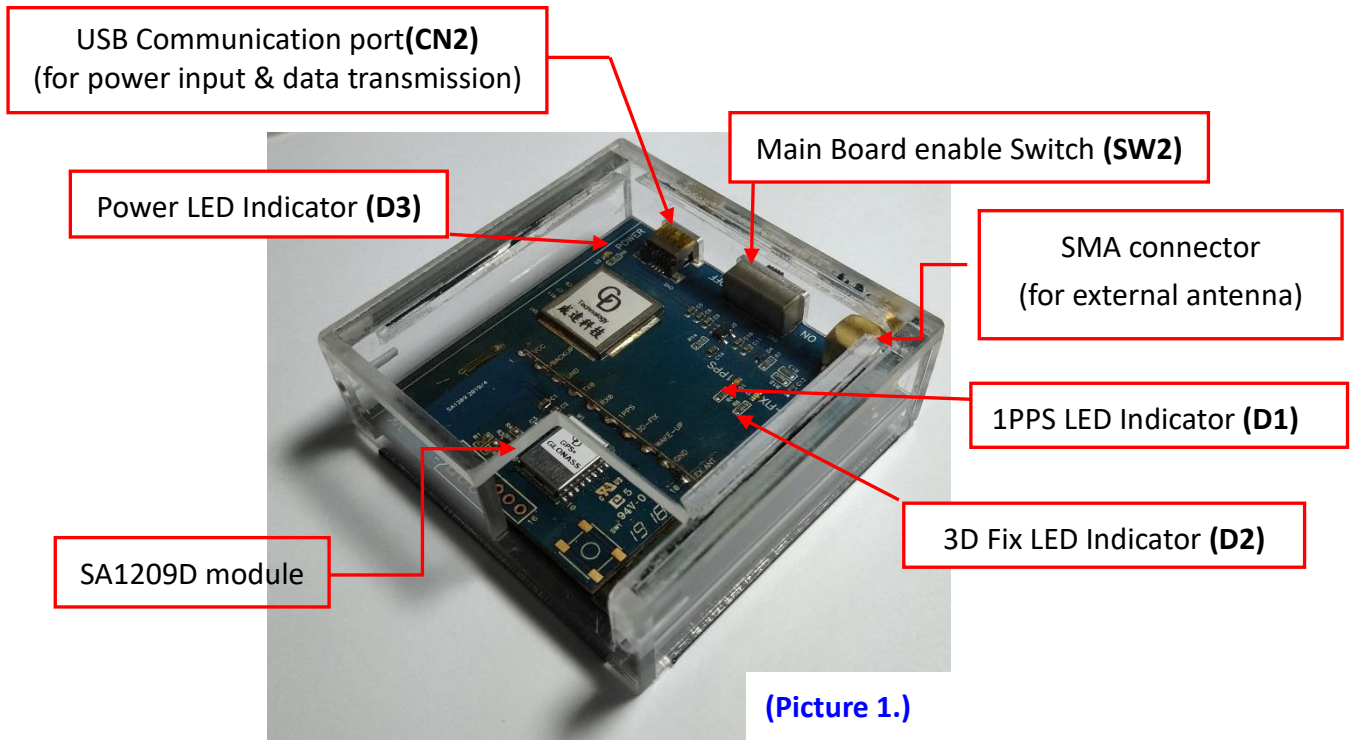

2. Operating Instruction

Step 1:

Connect the USB cable between PC and EV-Kit, the **Power LED Indicator (D3)** light On shown below as Picture 2. The USB cable is used to power the EV-Kit and transfer communication data.

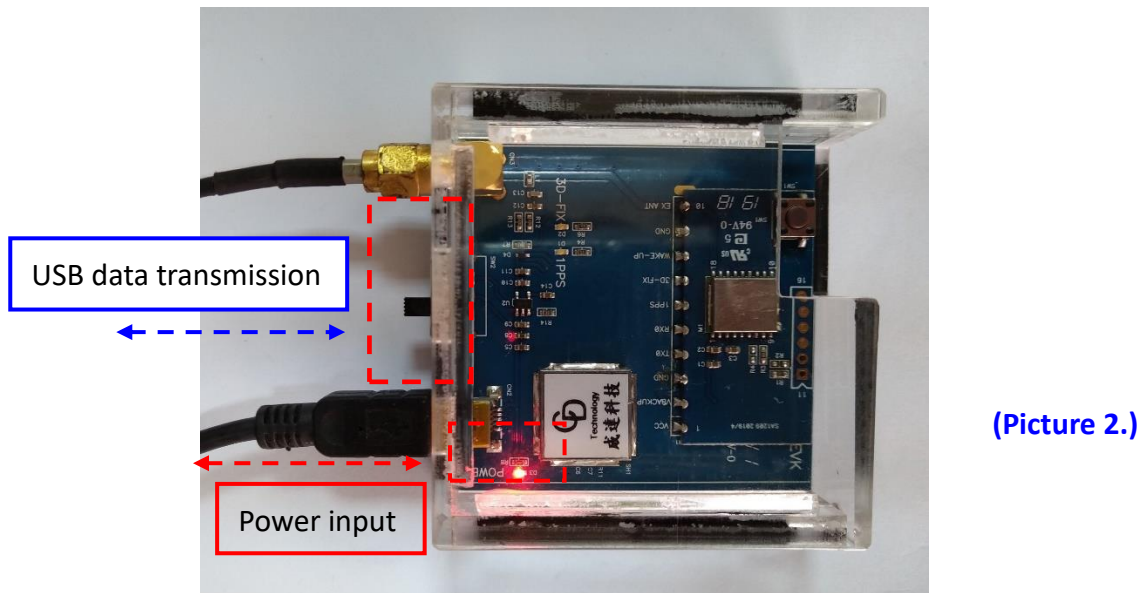

Step 2:

Switch the **Main Board enable Switch (SW2)** from **OFF** to **ON**.

Step 3:

- Double click < **GPS Viewer.exe**> to start the application, the main screen of the program should appear like Picture 3 shown below.
- Select the appropriate <**COM Port**> and < **Baud Rate** > value, like Picture 3 shown below.
- Finally click <**Open**> like the following Picture 3 then EV-Kit starting positioning like the following Picture 4.

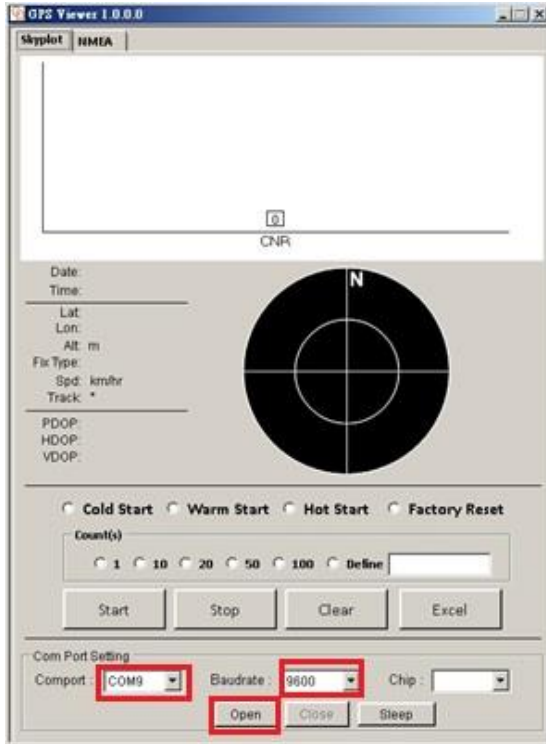

(Picture 3.)

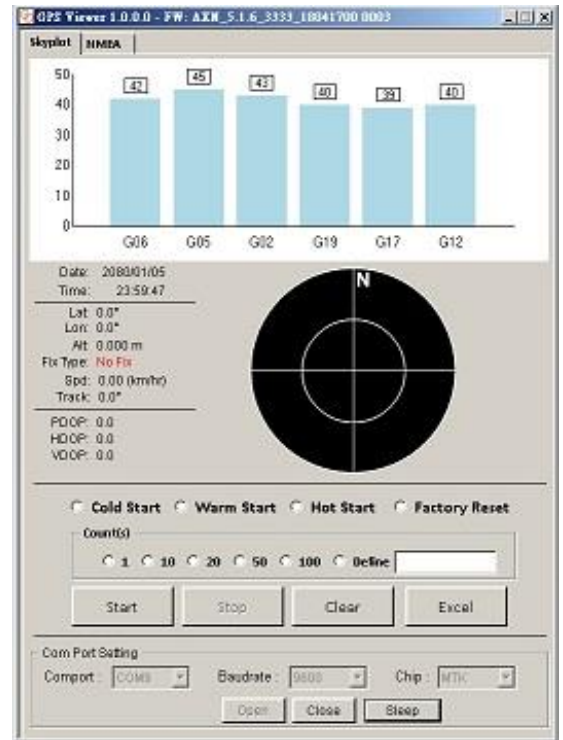

(Picture 4.)

- When SA1209D module starting positioning that **3D-Fix LED Indicator (D2)** green blinking like the below Picture 5.

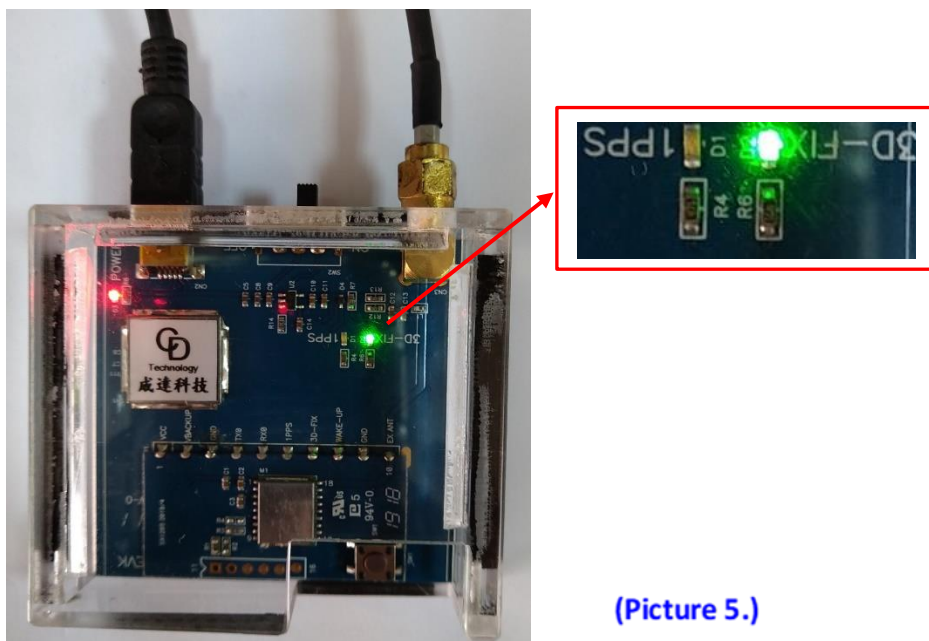

(Picture 5.)

- When SA1209D module finished positioning that **1PPS LED Indicator (D1)** green blinking like the below Picture 6.

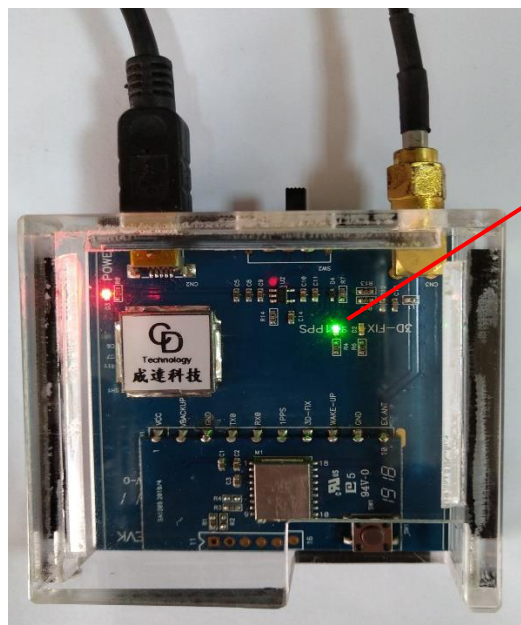
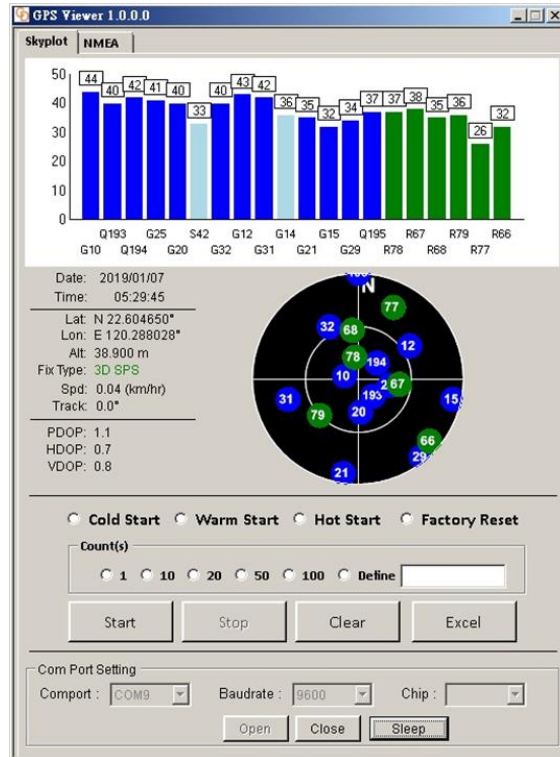

(Picture 6.)